

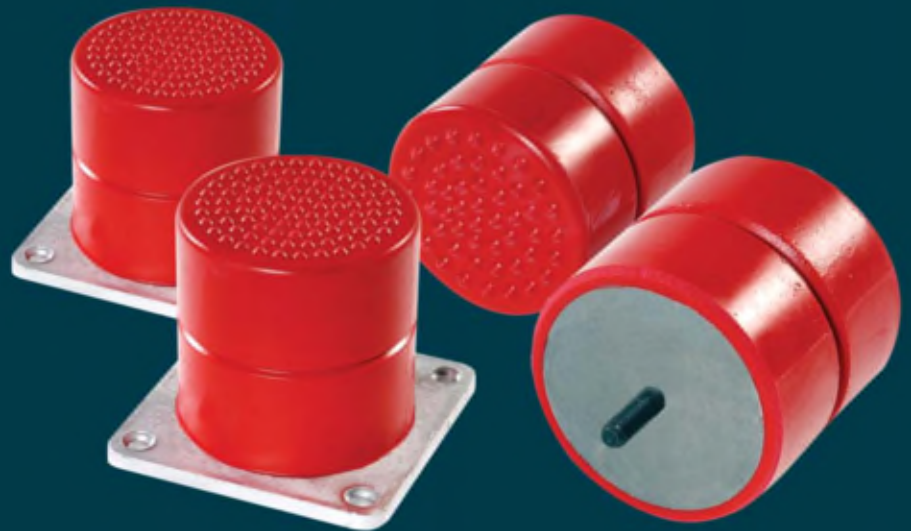

ITT

High Performance Industrial Bumpers



Engineered for life



www.LDA.be - LDA@LDA.be - +32(0)2-266 13 13



Control Technologies
Headquarters Valencia, CA



ITT Enidine Inc.
Orchard Park, NY



Cleveland Motion Controls
Cleveland, OH

ITT is a vibrant part of the global economy. We are a high-technology engineering and manufacturing company with approximately 40,000 employees operating in 55 countries. Our portfolio of businesses is aligned with enduring, global growth drivers, and our employees bring extraordinary focus to meeting the needs of the people who buy and use our products and services in all the markets we serve.

As part of our strategy to make the customer central to everything we do the Control Technologies and Energy Absorption value centers have combined. Both have strong ties to aerospace and industrial customers. The larger combined organization will optimize common relationships, core technologies, engineering strength and global scale to offer greater value for their common customers in terms of quality, cost and delivery.

At ITT We Make the Customer Central to Everything We Do.

ITT Corporation is a high-technology engineering and manufacturing company operating on all seven continents in three vital markets: water and fluids management, global defense and security, and motion and flow control. With a heritage of innovation, ITT partners with its customers to deliver extraordinary solutions that create more livable environments provide protection and safety and connect our world. Headquartered in White Plains, N.Y., the company generated 2008 sales of \$11.7 billion. www.itt.com





For over 40 years, Enidine's products have safely protected the crane operator and equipment during the transfer of materials and movement of products.

These products are individually sized to decelerate moving loads under various conditions and in compliance with industry mandated safety standards. They are engineered to conform with OSHA, AISE, CMAA and other safety specifications such as DIN and FEM.

Typical Applications

- Control of Bridge Cranes (Cab Operated)
- Portal Cranes
- Harbor Cranes
- Gantry Cranes
- Stacker Cranes
- Large Container Transport
- Ladle Transfer Cars

Features and Benefits of Enidine Bumper Products

- The bumper is manufactured of expanded polyurethane resin. The special microcellular structure consists of open and closed cells. This enables the buffers to provide high performance with excellent elasticity and energy absorption.
- This proprietary, anti-aging material is self-extinguishing and offers long service and shelf life.
- Rugged design suitable for outdoor use. Temperature capability from -40°C (-40°F) to +80°C (175°F)
- A steel safety chain is encased within each bumper and attached to the metallic support. This safety feature prevents potential injury or damage to property due to the bumper breaking away from its mounting in the case of catastrophic impact.
- Resistant to mechanical wear, oil, grease and gasoline.
- Stud and four bolt mounting configurations available.



RME

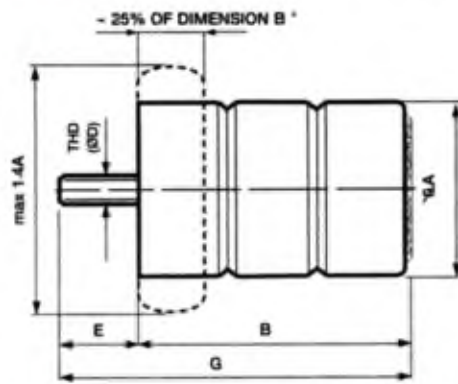

RMV

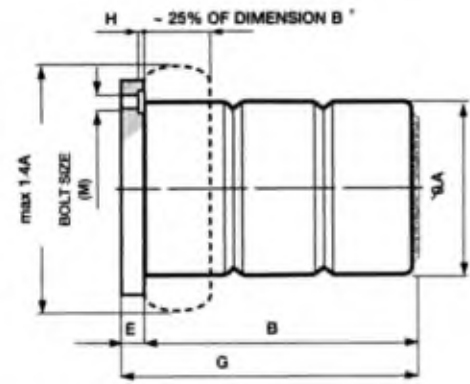
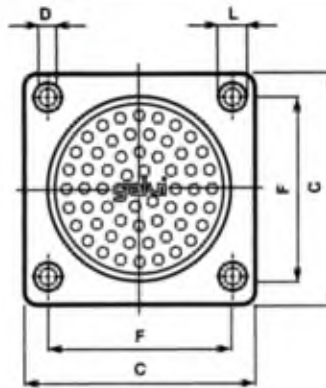

* The bumpers are designed to compress down to 25% of their free length. At this maximum compression, the outside diameter increases by 40%.

RME/RMV Bumper Selection Chart

Bumper Size Ø(A) x Height (B)		63 x 63				63 x 95				80 x 80			
Impact Velocity	Deflection	Max Energy/Cycle		Max Reaction Force		Max Energy/Cycle		Max Reaction Force		Max Energy/Cycle		Max Reaction Force	
[m/sec]	[%]	[kJ-m]	[Ft-lb]	[kN]	LBS	[kJ-m]	[Ft-lb]	[kN]	LBS	[kJ-m]	[Ft-lb]	[kN]	LBS
Static	30	0.01	7	2	450	0.01	7	2	450	0.04	30	3.2	720
	50	0.05	37	3.2	720	0.07	52	3.2	720	0.10	74	5.3	1193
	70	0.14	103	14	3150	0.21	155	14	3150	0.28	207	24	5400
1	30	0.03	22	3.2	720	0.05	37	3.2	720	0.07	52	5.3	1193
	50	0.08	59	4.7	1058	0.12	89	4.7	1058	0.16	118	8	1800
	70	0.18	133	13	2925	0.27	199	13	2925	0.36	266	22	4950
2	30	0.05	37	5.0	1125	0.07	52	5	1125	1.10	811	8.3	1868
	50	0.12	89	7.4	1665	0.18	133	7.4	1665	1.25	922	12	2700
	70	0.24	177	13	2925	0.36	266	13	2925	0.48	354	22	4950
3	30	0.08	59	8	1800	0.12	89	8	1800	0.15	111	13	2925
	50	0.20	148	12	2700	0.30	221	12	2700	0.42	310	20	4500
	70	0.40	295	19	4275	0.60	443	19	4275	0.80	590	30	6750
4	30	0.16	118	14	3150	0.24	177	14	3150	0.18	133	22	4950
	50	0.36	266	19	4275	0.54	398	19	4275	0.72	531	30	6750
	70	0.62	457	27	6075	0.93	686	27	6075	1.25	922	44	9900

Bumper Size Ø(A) x Height (B)		80 x 120				100 x 100				100 x 150			
Impact Velocity	Deflection	Max Energy/Cycle		Max Reaction Force		Max Energy/Cycle		Max Reaction Force		Max Energy/Cycle		Max Reaction Force	
[m/sec]	[%]	[kJ-m]	[Ft-lb]	[kN]	LBS	[kJ-m]	[Ft-lb]	[kN]	LBS	[kJ-m]	[Ft-lb]	[kN]	LBS
Static	30	0.06	44	3.2	720	0.07	52	5	1125	0.10	74	5	1125
	50	0.15	111	5.3	1193	0.20	148	8.5	1913	0.30	221	8.5	1913
	70	0.42	310	24	5400	0.56	413	37	8325	0.84	620	37	8325
1	30	0.10	74	5.3	1193	0.14	103	8.5	1913	0.21	155	8.5	1913
	50	0.24	177	8	1800	0.32	236	12	2700	0.48	354	12	2700
	70	0.54	398	22	4950	0.70	516	34	7650	1.05	774	34	7650
2	30	0.15	111	8	1868	0.20	148	13	2925	0.30	221	13	2925
	50	0.37	273	12	2700	0.50	368	19	4275	0.75	553	19	4275
	70	0.72	531	22	4950	0.94	693	34	7650	1.41	1040	34	7650
3	30	0.22	162	13	2925	0.32	236	21	4725	0.48	354	21	4725
	50	0.63	465	20	4500	0.82	605	31	6975	1.23	907	31	6975
	70	1.20	885	30	6750	1.54	1136	48	10800	2.31	1704	48	10800
4	30	0.27	199	22	4950	0.60	443	35	7875	0.90	664	35	7875
	50	1.08	797	30	6750	1.41	1040	48	10800	2.12	1564	48	10800
	70	1.87	1379	44	9900	2.50	1844	68	15300	3.75	2766	68	15300

Notes: 1. 1m/sec = 3.28 ft/sec = 196.8 ft/min = 2.23 miles/hr

2. RMV Buffers have one safety chain starting from 125.190 and two safety chains starting 315.315

3. To minimize reaction force, selection should be made on the basis of maximum 50% deflection. This will also provide ample reserve for the additional kinetic energy.



RME

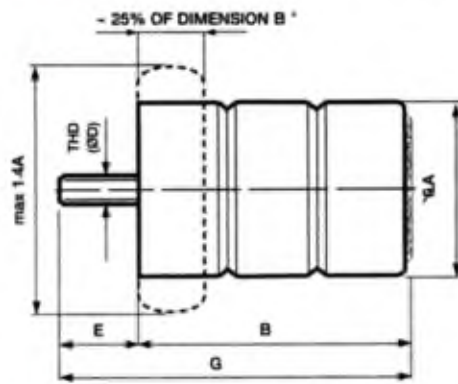

RMV

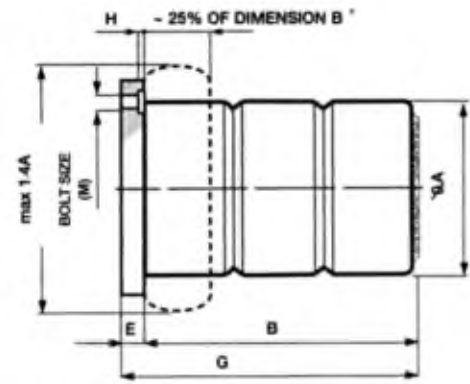
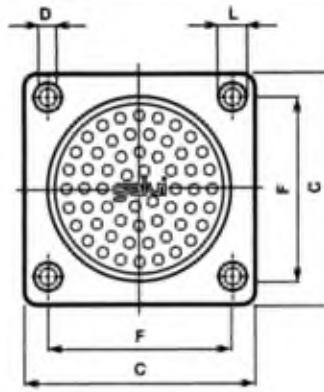

* The bumpers are designed to compress down to 25% of their free length. At this maximum compression, the outside diameter increases by 40%.

RME/RMV Bumper Selection Chart

Bumper Size Ø(A) x Height (B)		125 x 125				125 x 190				160 x 160			
Impact Velocity	Deflection	Max Energy/Cycle		Max Reaction Force		Max Energy/Cycle		Max Reaction Force		Max Energy/Cycle		Max Reaction Force	
[m/sec]	[%]	[kJ-m]	[Ft-lb]	[kN]	LBS	[kJ-m]	[Ft-lb]	[kN]	LBS	[kJ-m]	[Ft-lb]	[kN]	LBS
Static	30	0.15	111	8	1800	0.22	162	8	1800	0.30	221	13	2925
	50	0.38	280	13	2925	0.57	420	13	2925	0.80	590	21	4725
	70	1.02	752	58	13050	1.53	1128	58	13050	2.26	1667	93	20925
1	30	0.28	207	13	2925	0.42	310	13	2925	0.54	398	21	4725
	50	0.64	472	19	4275	0.96	708	19	4275	1.27	937	31	6975
	70	1.42	1047	53	11925	2.13	1571	53	11925	2.87	2117	86	19350
2	30	0.4	295	20	4500	0.60	443	20	4500	0.82	605	33	7425
	50	1	738	29	6525	1.50	1106	29	6525	2	1475	49	11025
	70	1.9	1401	53	11925	2.85	2102	53	11925	3.84	2832	86	19350
3	30	0.66	487	32	7200	0.99	730	32	7200	1.35	996	53	11925
	50	1.65	1217	48	10800	2.47	1822	48	10800	3.27	2412	80	18000
	70	3.12	2301	75	16875	4.68	3452	75	16875	6.30	4647	120	27000
4	30	1.22	900	55	12375	1.83	1350	55	12375	2.50	1844	90	20250
	50	2.84	2095	75	16875	4.26	3142	75	16875	5.60	4130	120	27000
	70	5	3688	106	23850	7.50	5532	106	23850	10	7376	174	39150

Bumper Size Ø(A) x Height (B)		160 x 240				200 x 200				200 x 300			
Impact Velocity	Deflection	Max Energy/Cycle		Max Reaction Force		Max Energy/Cycle		Max Reaction Force		Max Energy/Cycle		Max Reaction Force	
[m/sec]	[%]	[kJ-m]	[Ft-lb]	[kN]	LBS	[kJ-m]	[Ft-lb]	[kN]	LBS	[kJ-m]	[Ft-lb]	[kN]	LBS
Static	30	0.45	332	13	2925	0.60	443	20	4500	0.90	664	20	4500
	50	1.20	885	21	4725	1.60	1180	34	7650	2.40	1770	34	7650
	70	3.39	2500	93	20925	4.50	3319	147	33075	6.75	4979	147	33075
1	30	0.81	597	21	4725	1.20	885	33	7425	1.80	1328	33	7425
	50	1.90	1401	31	6975	2.60	1918	50	11250	3.90	2876	50	11250
	70	4.30	3172	86	19350	5.76	4248	135	30375	8.64	6373	135	30375
2	30	1.23	907	33	7425	1.70	1254	52	11700	2.55	1881	52	11700
	50	3	2213	49	11025	4	2950	76	17100	6	4425	76	17100
	70	5.76	4248	86	19350	7.64	5635	135	30375	11.46	8452	135	30375
3	30	2.02	1490	53	11925	2.70	1991	84	18900	4.05	2987	84	18900
	50	4.90	3614	80	18000	6.60	4868	120	27000	9.90	7302	120	27000
	70	9.45	6970	120	27000	12.50	9220	187	42075	18.75	13829	187	42075
4	30	3.75	2766	90	20250	4.90	3614	14	3150	7.35	5421	14	3150
	50	8.40	6196	120	27000	11.50	8482	190	42750	17.25	12723	190	42750
	70	15	11063	174	39150	20	14751	275	61875	30	22127	275	61875

Notes: 1. 1m/sec = 3.28 ft/sec = 196.8 ft/min = 2.23 miles/hr

2. RMV Buffers have one safety chain starting from 125.190 and two safety chains starting 315.315

3. To minimize reaction force, selection should be made on the basis of maximum 50% deflection. This will also provide ample reserve for the additional kinetic energy.



RME

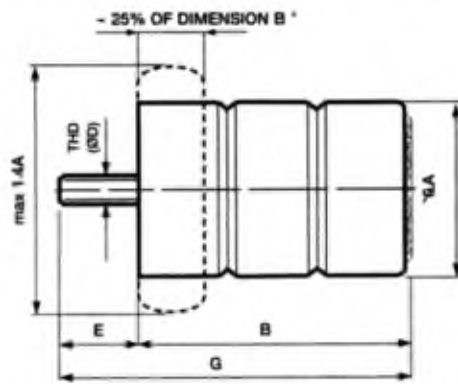

RMV

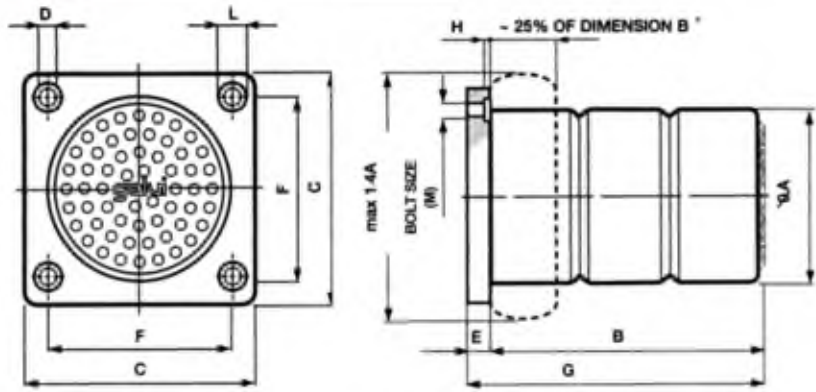

* The bumpers are designed to compress down to 25% of their free length. At this maximum compression, the outside diameter increases by 40%.

RME/RMV Bumper Selection Chart

Bumper Size Ø(A) x Height (B)		250 x 250				250 x 375				315 x 315			
Impact Velocity	Deflection	Max Energy/Cycle		Max Reaction Force		Max Energy/Cycle		Max Reaction Force		Max Energy/Cycle		Max Reaction Force	
[m/sec]	[%]	[kJ-m]	[Ft-lb]	[kN]	LBS	[kJ-m]	[Ft-lb]	[kN]	LBS	[kJ-m]	[Ft-lb]	[kN]	LBS
static	30	1.20	885	32	7200	1.80	1328	32	7200	2.50	1844	50	11250
	50	3.10	2286	53	11925	4.65	3430	53	11925	6.42	4735	85	19125
	70	9	6638	230	51750	13.50	9957	230	51750	18.00	13276	370	83250
1	30	2.30	1696	53	11925	3.45	2545	53	11925	4.60	3393	82	18450
	50	5.20	3835	76	17100	7.80	5753	76	17100	10.40	7671	120	27000
	70	11.70	8629	213	47925	17.55	12944	213	47925	23.00	16964	340	76500
2	30	3.40	2508	80	18000	5.10	3762	80	18000	6.60	4868	128	28800
	50	8.30	6122	120	27000	12.34	9101	120	27000	16.60	12243	187	42075
	70	15.50	11432	213	47925	23.25	17148	213	47925	30.60	22569	340	76500
3	30	5.50	4057	130	29250	8.25	6085	130	29250	11	8113	208	46800
	50	13.50	9957	195	43875	20.25	14936	195	43875	27	19914	300	67500
	70	25	18439	295	66375	37.50	27659	295	66375	50	36878	480	108000
4	30	10	7376	220	49500	15	11063	220	49500	20	14751	350	78750
	50	23	16964	300	67500	34.50	25446	300	67500	45.80	33780	475	106875
	70	40	29502	430	96750	60	44254	430	96750	78	57530	690	155250

Bumper Size Ø(A) x Height (B)		315 x 475				400 x 400				500 x 500			
Impact Velocity	Deflection	Max Energy/Cycle		Max Reaction Force		Max Energy/Cycle		Max Reaction Force		Max Energy/Cycle		Max Reaction Force	
[m/sec]	[%]	[kJ-m]	[Ft-lb]	[kN]	LBS	[kJ-m]	[Ft-lb]	[kN]	LBS	[kJ-m]	[Ft-lb]	[kN]	LBS
static	30	3.75	2766	50	11250	4.4	3245	82	18450	9.6	7081	128	28800
	50	9.63	7103	85	19125	12.5	9220	135	30375	27	19914	210	47250
	70	27	19914	370	83250	35	25815	600	135000	73	53842	950	213750
1	30	6.90	5089	82	18450	9	6638	132	29700	18	13276	212	47700
	50	15.60	11506	120	27000	20.2	14899	195	43875	41.4	30535	310	69750
	70	34.50	25446	340	76500	45	33190	550	123750	91	67118	875	196875
2	30	9.90	7302	128	28800	14	10326	208	46800	28	20652	332	74700
	50	24.90	18365	187	42075	32	23602	300	67500	65.3	48163	480	108000
	70	45.90	33854	340	76500	60	44254	550	123750	120	88507	875	196875
3	30	16.50	12170	208	46800	22	16226	332	74700	44	32453	533	119925
	50	40.50	29871	300	67500	52.5	38722	500	112500	105	77444	780	175500
	70	75	55317	480	108000	100	73756	775	174375	200	147512	1190	267750
4	30	30	22127	350	78750	40	29502	565	127125	78	57530	890	200250
	50	68.70	50670	475	106875	90	66380	770	173250	178	131286	1210	272250
	70	117	86295	690	155250	155	114322	1100	247500	306	225693	1670	375750

Notes: 1. 1 m/sec = 3.28 ft/sec = 196.8 ft/min = 2.23 miles/hr

2. RMV Buffers have one safety chain starting from 125.190 and two safety chains starting 315.315

3. To minimize reaction force, selection should be made on the basis of maximum 50% deflection. This will also provide ample reserve for the additional kinetic energy.



RME

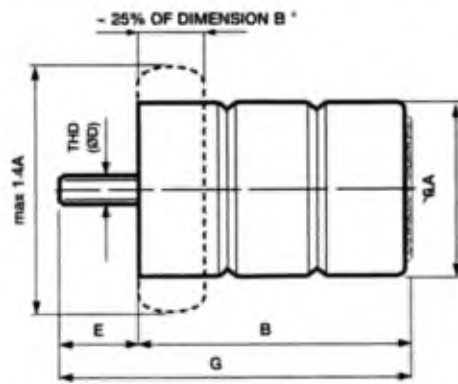

RMV

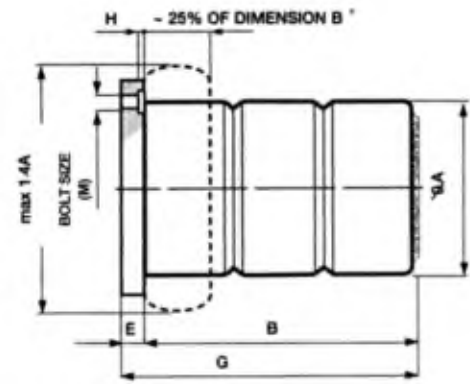
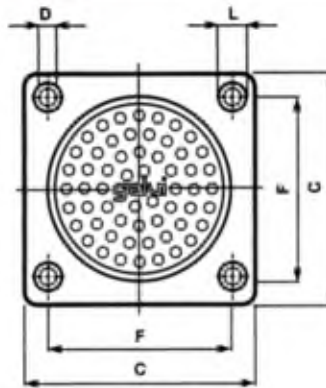

* The bumpers are designed to compress down to 25% of their free length. At this maximum compression, the outside diameter increases by 40%.

RME/RMV Bumper Selection Chart

Enidine Part No.	Model Number	ØA	B	ØD	E	G	Weight (kg)
46RME080080	RME.080.080	80	80	M12	35	115	0,350
46RME080120	RME.080.120	80	120	M12	35	155	0,455
46RME100100	RME.100.100	100	100	M12	35	135	0,600
46RME100150	RME.100.150	100	150	M12	35	185	0,800
46RME125125	RME.125.125	125	125	M12	35	160	1,065
46RME125190	RME.125.190	125	190	M12	35	225	1,380
46RME160160	RME.160.160	160	160	M12	40	200	2,620
46RME160240	RME.160.240	160	240	M12	40	280	3,490
46RME200200	RME.200.200	200	200	M12	40	240	4,510
46RME200300	RME.200.300	200	300	M12	40	340	6,160
46RME250250	RME.250.250	250	250	M24	80	330	9,240
46RME250375	RME.250.375	250	375	M24	80	455	12,390
46RME315315	RME.315.315	315	315	M24	80	395	17,190
46RME315475	RME.315.475	315	475	M24	80	555	23,540
46RME400400	RME.400.400	400	400	M30	80	480	34,780
46RME400600	RME.400.600	400	600	M30	80	680	48,580

Enidine Part No.	Model Number	ØA	B	C	D	E	F	G	H	L	M	Weight (kg)
46RMV063063	RMV.063.063	63	63	80	9	8	63	71	-	-	M8	0,230
46RMV063095	RMV.063.095	63	95	80	9	8	63	103	-	-	M8	0,275
46RMV080080	RMV.080.080	80	80	100	11	10	80	90	-	-	M10	0,440
46RMV080120	RMV.080.120	80	120	100	11	10	80	130	-	-	M10	0,545
46RMV100100	RMV.100.100	100	100	125	11	10	100	110	-	-	M10	0,750
46RMV100150	RMV.100.150	100	150	125	11	10	100	160	-	-	M10	0,950
46RMV125125	RMV.125.125	125	125	160	14	12	125	137	5	20	M12	1,535
46RMV125190	RMV.125.190	125	190	160	14	12	125	202	5	20	M12	1,850
46RMV160160	RMV.160.160	160	160	200	14	12	160	172	5	20	M12	2,950
46RMV160240	RMV.160.240	160	240	200	14	12	160	252	5	20	M12	3,820
46RMV200200	RMV.200.200	200	200	250	18	15	200	215	6	26	M16	5,600
46RMV200300	RMV.200.300	200	300	250	18	15	200	315	6	26	M16	7,250
46RMV250250	RMV.250.250	250	250	315	18	15	250	265	6	26	M16	10,000
46RMV250375	RMV.250.375	250	375	315	18	15	250	390	6	26	M16	13,150
46RMV315315	RMV.315.315	315	315	400	18	15	315	330	6	26	M16	18,200
46RMV315475	RMV.315.475	315	475	400	18	15	315	490	6	26	M16	24,550
46RMV400400	RMV.400.400	400	400	500	22	20	400	420	7	33	M20	39,000
46RMV400600	RMV.400.600	400	600	500	22	20	400	620	7	33	M20	52,280
46RMV500500	RMV.500.500	500	500	630	26	20	500	520	8	39	M24	76,300

Subject to change without notice.

All Dimensions are in mm.



Aerospace Controls
28150 Industry Drive
Valencia, CA 91355
Phone: 661-295-4000
Fax: 661-294-1750
www.ittaerospace.com

Cleveland Motion Controls, Inc.
7550 Hub Parkway
Cleveland, Ohio 44125
Phone: 216-524-8800
Fax: 216-642-2199
www.cmcccontrols.com

ITT Control Technologies GmbH
Werkstrasse 5
D-64732, Bad Koenig, Germany
Phone: +49 6063 9314 0
Fax: +49 6063 9314 44
www.cmcccontrols.com

Compact Automation Products
Turn-Act
105 Commerce Way
Westminster, SC 29693
Phone: 864-647-9521
Fax: 864-647-9574
www.itt.com
www.compactautomation.com
www.turn-act.com

Conoflow
5154 Highway 78
St. George, SC 29477-07668
Phone: 843-563-9281
Fax: 843-563-2131
www.conoflow.com

ITT Enidine Inc.
7 Centre Drive
Orchard Park, New York 14127
Phone: 716-662-1900
Fax: 716-667-1385
Email: industrialsales@itt.com
www.enidine.com

ITT High Precision Manufactured Products (Wuxi) Co. Ltd.
J Room 19th Fl ZMI Plaza
No. 445 Kaixuan Road
Hangzhou, Zhejiang, China
Phone: 0086-571-86714399
Fax: 0086-571-86714055
www.itt.com
www.enidine.cn

KALIBURN Inc.
4130 Carolina Commerce Parkway
Ladson, SC 29456
Phone: 843-795-4286
Fax: 843-795-8931
www.kaliburn.net

Neo-Dyn®
28150 Industry Drive
Valencia, CA 91355
Phone: 661-295-4000
Fax: 661-294-1750
www.neodyn.com