

The TLR slides are the world's only telescopic slides system which incorporated self-aligning feature to absorb parallelism errors of the mounting surfaces, when used in pairs.

The TLR slides are designed for heavy duty High-Tech telescopic applications, with precise motorized movement, requiring constant smooth sliding performance with no play. Recommended for high frequency applications.

The high performance is provided by use of double-row precision bearings, strong rails with hardened and honed raceways, fixed to a rigid intermediate S-shaped steel plate, assuring high load capacities and low flexion at even fully extended position.

The TLR slides guarantee maintenance free operation, thanks to strong raceway wipers and longitudinal seals for dust and impurity protection. An integrated lubed for-life greasing system, assuring a constant thin layer of lubrication on the raceway surfaces, for a long operation period.

TLR system offers unique possibilities and benefits for all kind of automation applications with variable strokes, for which a ball-cage slide often has ball-cage creeping problems, i.e. friction problems to reach full extension, as ball-cage is forced out to end position, instead of rolling.

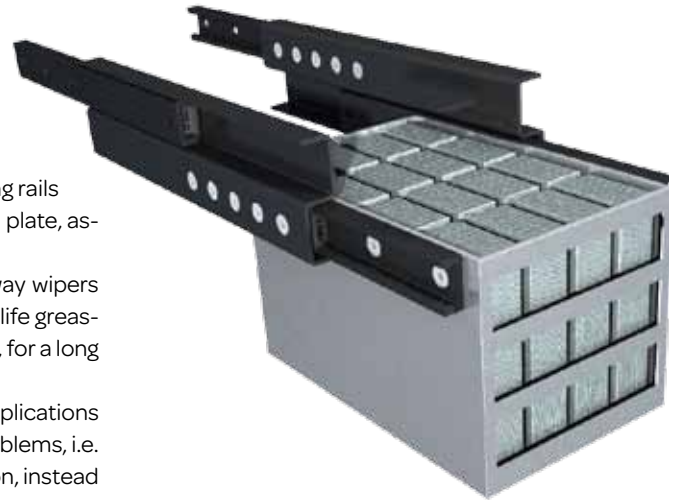

TLRX slides for corrosive ambients

For corrosive ambients is available TLRX, with all components and intermediate element in stainless steel INOX, except the rails, which have T RACE-NOX anti-corrosion treatment; a oxidation treatment and impregnation in hot oil, to offer a good corrosion resistance.

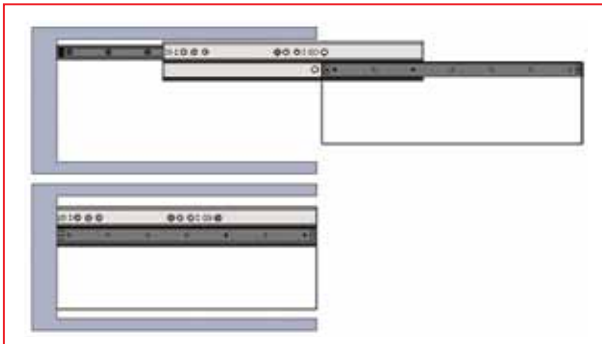

Extension

The TLR slides allow for an extension equal to the closed slide plus a small constant.

The extension is obtained by movement of the intermediate element and the lower rail, while the upper rail is fixed to structure.

As it can be seen on left figure, the movement of the lower rail is more than the upper rail, due to optimizing of load capacity and the fact that the rollers are positioned on the intermediate element to offer max load capacity in this position. Hereby the TLR slides are asymmetric, so the slides must be ordered as left side slide TLRs and right side slide TLRD and when installed the product code must be on top side.

The load capacities are all indicated per single rail, with centered load position, equal to half the rail in extended position.

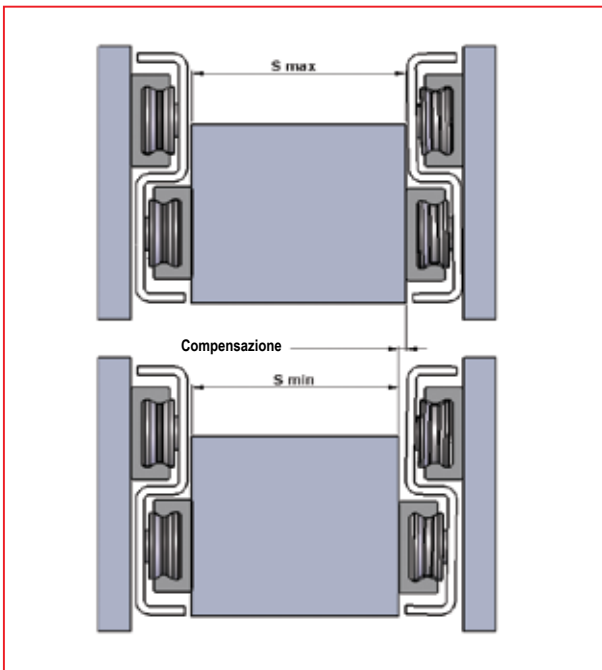

Self-aligning capacity

When TLR slides are used in pairs, they offer the possibility to absorb minor structural errors or non-precise installation, which otherwise would much increase the required force for moving the mobile part, in both extending and closing direction. A typical problem for ball-cage telescopic slides.

Using a pair of self-aligning TLR slides, smooth low friction movement is assured, along with a more easy installation and/or less precise workings of structure, i.e. cost savings. The self-aligning feature is obtained by having a combination of floating rollers and guiding rollers in the TLR..A. i.e. allowing for a minor rotation of the rails, maintaining the preload in both upper and lower rails of the TLR..A slide.

The suffix A in TLR..A, indicates "Aligning" The concept is well illustrated in the catalogue section MONORACE, for which the base components have their origin.

To be noted that the rotation of the TLR..A slide hereby changes the nominal value of 18,6mm to 17,2mm (S min) – 19,0mm (S max) while compensating dimensional errors on mobile structure or distance errors between the two lateral sides of fixed structure, for which the upper rails are fixed to. Herewith avoiding binding-problems, with would much increase friction force, with consequent reduced load capacity and expected life-time.

The TLR..A is in general always used in pair with a standard TLR, to assure good lateral stability. However good self-aligning can also be obtained for movement of vertical panels, with use of TLR..A at top to absorb some mis-alignment, and with some retainer guidance at lower part. Please refer to page 70, for further information.

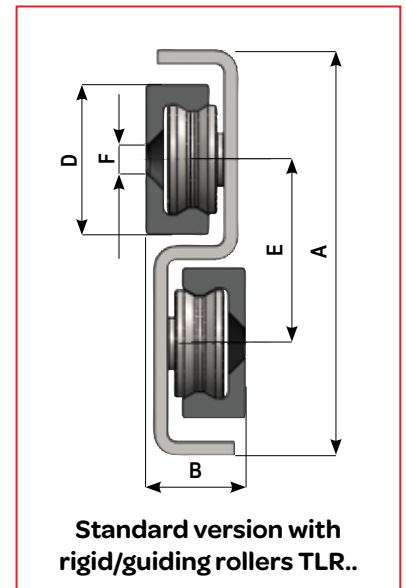
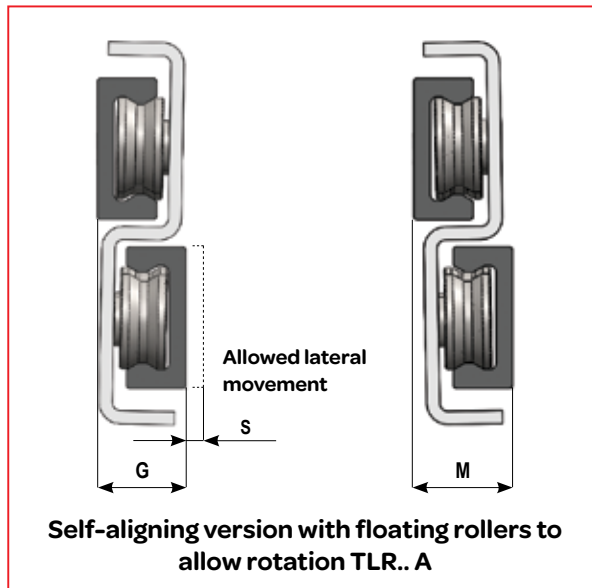
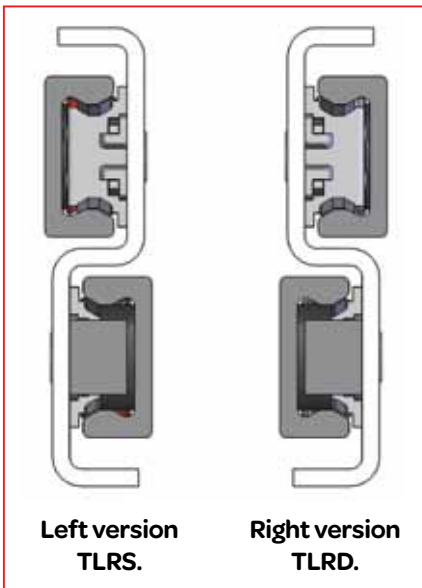
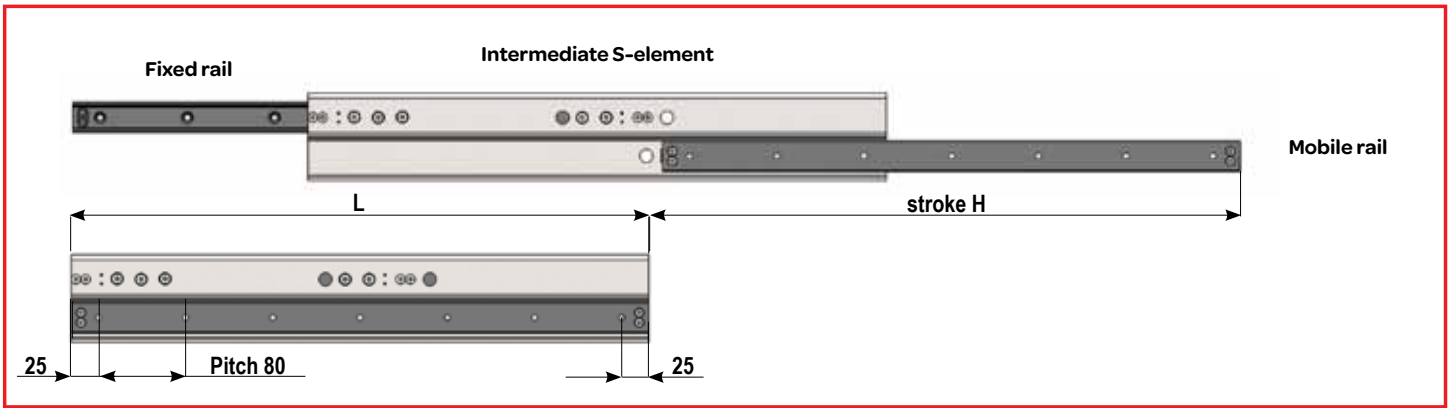

Code	A (mm)	B (mm)	D (mm)	E (mm)	F (mm)	G (mm)	M (mm)	S (mm)
TLR18	52	15,2	18	25	Ø 4,5 for screw M4 DIN7991	14,7	15,7	1
TLR.28	80	18,6	28	35	Ø 5,5 for screw M5 DIN7991	17,2	19	1,8
TLR.43	116	28	43	52	Ø 8,5 for screw M8 DIN7991	26,8	30	3,2

For corrosive ambients is available TLRX., with all components and intermediate element in INOX, except the rail, which have T RACE NOX anti-corrosion treatment; a oxidation treatment and impregnation in hot oil, to offer a good corrosion resistance. Same dimension and performance as standard version TLR.

Order code ex.:

- TLRD28-370** = standard rigid right slide, length 370mm
- TLRS28A-370** = self-aligning left slide, length 370mm
- TLRDx28A-370** = self-aligning INOX right slide, length 370mm

The listed load capacities Co rad, are per single slide, with the load centered, i.e. in the middle of the extended lower rail, P. In case the load is not centered, ex. The load is more towards tip, the load capacity is reduced, please refer to page 74. For further info and flexion "f" indications. TLR slides must be installed with the code mark and upper rail at top-side, while mobile part is fixed to lower rail.

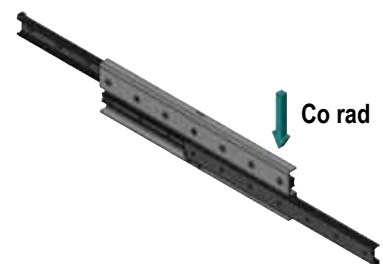

Code	Lenght L (mm)	Stroke H (mm)	Dynamic coefficient C (N)	Loead capacity Co rad (N)	Weight (kg)
TLR18-290	290	290	731	355	0,9
TLR18-370	370	370	969	470	1,2
TLR18-450	450	450	1.115	541	1,4
TLR18-530	530	530	1.214	589	1,6
TLR18-610	610	610	1.286	623	1,9
TLR18-690	690	690	1.324	642	2,1
TLR18-770	770	770	1.344	652	2,3

Code	Lenght L (mm)	Stroke H (mm)	Dynamic coefficient C (N)	Loead capacity Co rad (N)	Weight (kg)
TLR.28-370	370	380	1578	798	2,1
TLR.28-450	450	460	1859	940	2,5
TLR.28-530	530	540	2044	1034	2,9
TLR.28-610	610	620	2711	1371	3,3
TLR.28-690	690	700	2933	1483	3,7
TLR.28-770	770	780	3083	1560	4,1
TLR.28-850	850	860	3180	1608	4,5
TLR.28-930	930	940	3259	1631	4,9
TLR.28-1010	1010	1020	3325	1519	5,3
TLR.28-1090	1090	1100	3380	1421	5,7
TLR.28-1170	1170	1180	3428	1334	6,1
TLR.28-1250	1250	1260	3469	1258	6,5
TLR.28-1330	1330	1340	3505	1190	6,9
TLR.28-1410	1410	1420	3537	1129	7,3
TLR.28-1490	1490	1500	3565	1073	7,7

Code	Lenght L (mm)	Stroke H (mm)	Dynamic coefficient C (N)	Loead capacity Co rad (N)	Weight (kg)
TLR.43-530	530	540	4074	2078	6,4
TLR.43-610	610	620	4241	2163	7,3
TLR.43-690	690	700	6154	3139	8,2
TLR.43-770	770	780	6553	3342	9,1
TLR.43-850	850	860	6869	3504	10
TLR.43-930	930	940	7127	3635	10,9
TLR.43-1010	1010	1020	7340	3744	11,8
TLR.43-1090	1090	1100	7520	3835	12,7
TLR.43-1170	1170	1180	7673	3784	13,6
TLR.43-1250	1250	1260	7806	3574	14,5
TLR.43-1330	1330	1340	7922	3386	15,4
TLR.43-1410	1410	1420	8024	3217	16,3
TLR.43-1490	1490	1500	8114	3064	17,2
TLR.43-1570	1570	1580	8195	2925	18,1
TLR.43-1650	1650	1660	8267	2798	19
TLR.43-1730	1730	1740	8333	2682	19,9
TLR.43-1810	1810	1820	8392	2574	20,8
TLR.43-1890	1890	1900	8447	2476	21,7
TLR.43-1970	1970	1980	8496	2384	22,6